

Council for
Higher Education
Accreditation



CHEA 2009 Annual Conference and International Seminar

Combating Degree Mills

Stamenka
Uvalić-Trumbić



John
Daniel

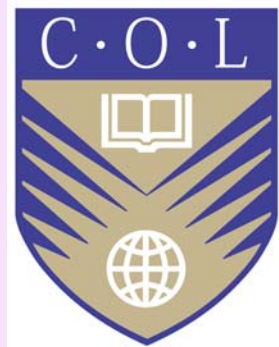



Sonoma State University

The Trustees of

The California State University

on recommendation of the Faculty have conferred upon

Robert L. Baird

the degree of

Bachelor of Science

in Business Administration (Marketing)

with all the rights and privileges pertaining thereto.

Given this twenty-second day of May, two thousand and four.



Arnold Schwarzenegger
Governor of California and President of the Trustees

Charles B. Reed
Chancellor of The California State University

Debra S. Fagan
Chieft of the Board of Trustees

Thomas
President of the University



BEWARE



DEGREE MILLS & BOGUS COLLEGES

WHY DEGREE MILLS?

- High demand for Higher Education



WHY DEGREE MILLS?



- More study abroad

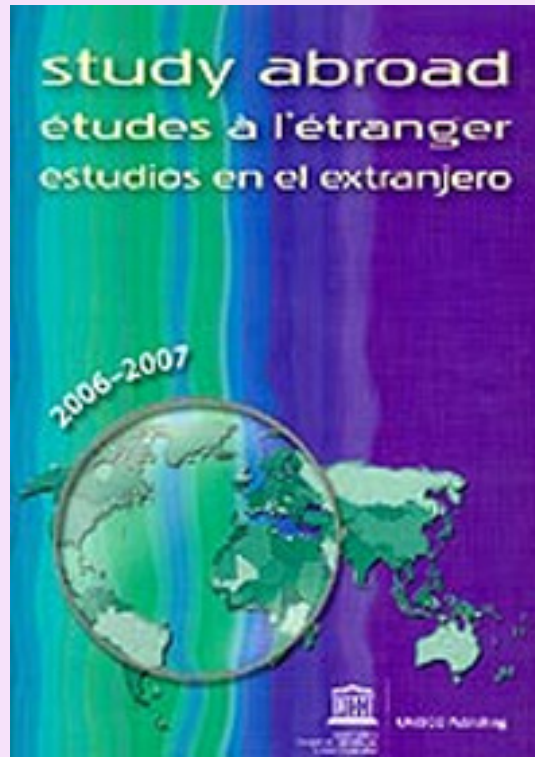

WHY DEGREE MILLS?



- The Internet



Our Campus

Part 1

Intergovernmental organizations:

- Combating degree mills by putting in place structures and processes to support the internationalization of higher education.
- Helping students find their way around in this new world

Part 2

What can you do about degree mills?

- No magic bullet
- Action on various fronts



The Commonwealth



The Small States





Why UNESCO?

INTERNATIONALIZATION OF HIGHER EDUCATION:

- Growing Demand; Diversification of Providers; Increased Mobility; the Internet
- Quality Assurance and Qualifications Recognition



Why UNESCO?

INTERNATIONALIZATION OF QUALITY ASSURANCE:

- OECD – Feasibility study AHELO
- Rankings
- Bologna : European Standards and Guidelines
- International and regional networks:
INQAAHE;
ANQAHE; APQN; AfriQUAN; CANQATE;
RIACES

Why UNESCO?



GLOBAL OUTREACH THROUGH:

Standard-Setting :

- UNESCO Conventions for the Recognition of Degrees in Higher Education;
- 2005 Guidelines for Quality Provision in CBHE

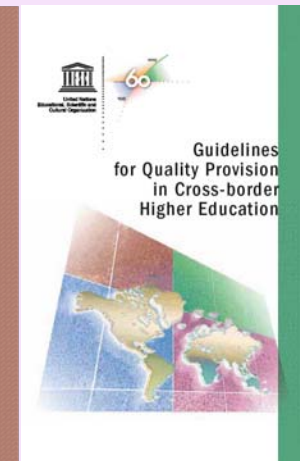
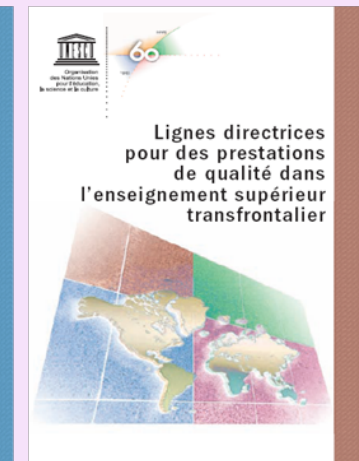
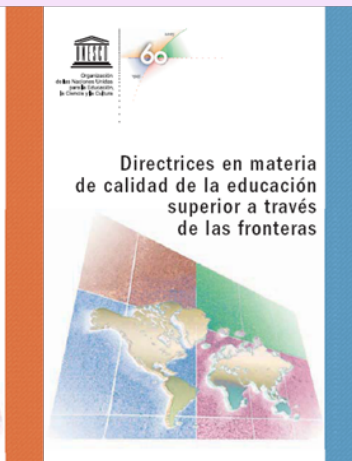

Why UNESCO?



GLOBAL OUTREACH THROUGH:

Capacity-Building:

- UNESCO Global Forum on QA, Accreditation and the Recognition of Qualification (2002; 2004; 2007)
- UNESCO-World Bank Global Initiative GIQAC



Why UNESCO?



GLOBAL OUTREACH THROUGH:

Clearinghouse

- Study Abroad
- Portal on HEIs
- Effective International Practices for Degree Mills



Guidelines for quality provision in cross-border higher education UNESCO and OECD

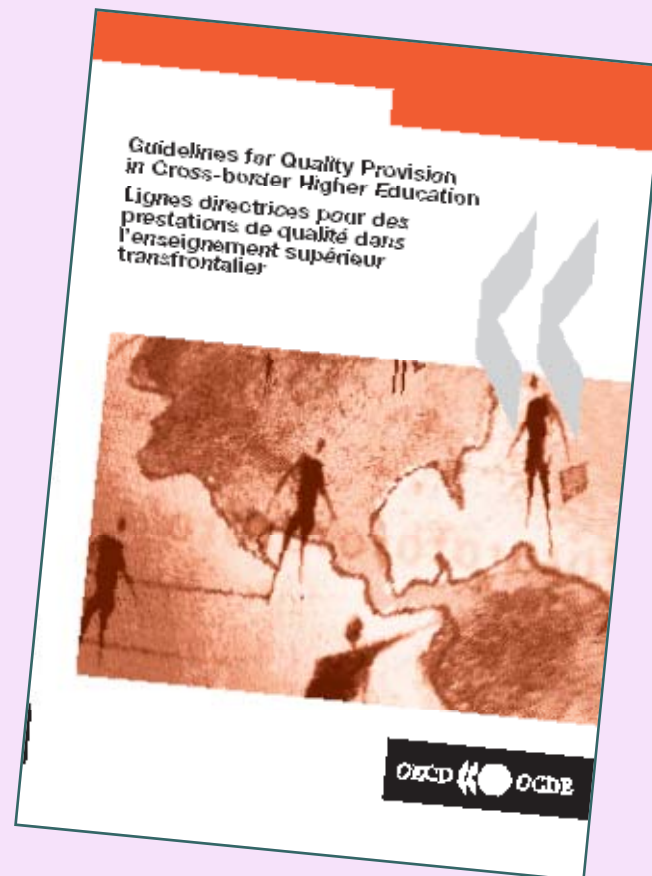
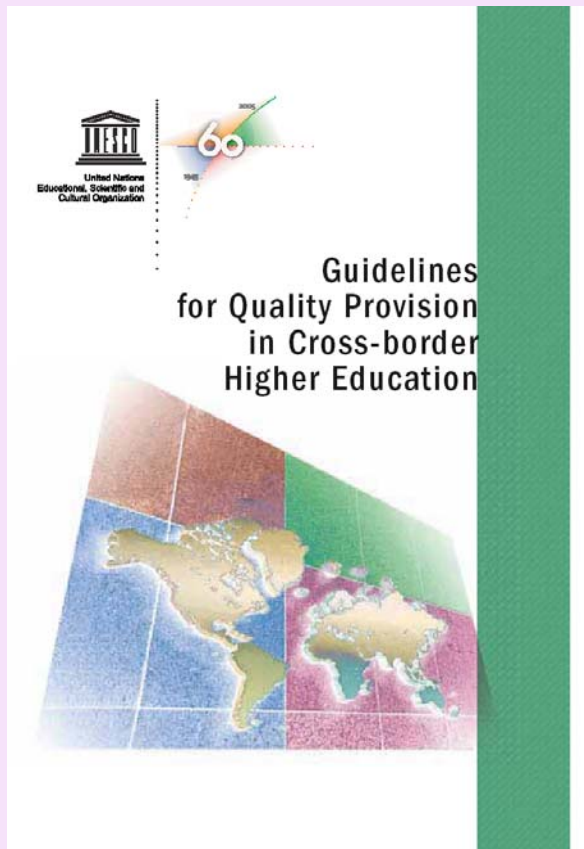



United Nations
Educational, Scientific and
Cultural Organization

60

Guidelines for Quality Provision in Cross-border Higher Education



Organisation
des Nations Unies
pour l'éducation,
la science et la culture

60

Lignes directrices pour des prestations de qualité dans l'enseignement supérieur transfrontalier



Organización
de las Naciones Unidas
para la Educación,
la Ciencia y la Cultura

60

Directrices en materia de calidad de la educación superior a través de las fronteras



Организация
Объединённых Наций по
вопросам образования,
науки и культуры

60

Руководящие принципы для обеспечения качества в трансграничном высшем образовании

60



منظمة
الأمم المتحدة
للثقافة والعلم
واللغة

مبادئ توجيهية بشأن جودة التعليم العالي الموفر عبر الحدود



联合国教育、
科学及文化组织

60

保障跨国界 高等教育办学质量 的指导方针

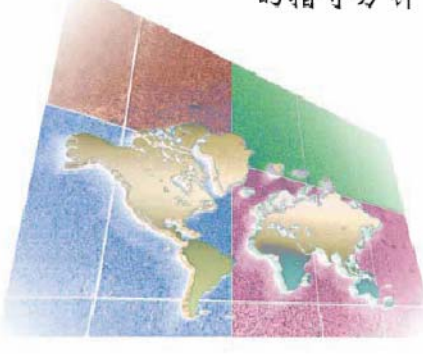



United Nations
Educational, Scientific and
Cultural Organization

New capacity- building initiative **GIQAC**



- A UNESCO-WB partnership to support capacity-building in developing and transition countries
- Launched in January 2008 for a 3-year period
- Participants 2008: regional QA networks from Africa, Arab States, Asia and the Pacific, Latin America/Caribbean and the international QA network INQAAHE

UNESCO Portal on Higher Education Institutions

<http://www.unesco.org/education/portal/hed-institutions>

UNESCO.org Education Natural Sciences Social & Human Sciences Culture Communication & Information

United Nations Educational, Scientific and Cultural Organization

EDUCATION

Text Sitemap OK Advanced search English Français Español

UNESCO.org / Education / Higher Education / UNESCO Portal on Higher Education Institutions /

List of Countries UNESCO Portal on Higher Education Institutions Project

Choose

The UNESCO Portal on Higher Education Institutions

This portal offers access to on-line information on higher education institutions recognized or otherwise sanctioned by competent authorities in participating countries.

It provides students, employers and other interested parties with access to authoritative and up-to-date information on the status of higher education institutions and quality assurance in these countries.

Currently, information can be accessed on the following countries: Argentina, Australia, Canada, China, Egypt, Jamaica, Japan, Kenya, Malaysia, Nigeria, Norway, United Kingdom, and the United States of America. In the next stage of the project, the number of countries covered will be expanded.

The country information on this portal is managed and updated by relevant authorities in participating countries. More information on the national processes for recognizing or otherwise sanctioning institutions is available on the country pages.

Users are encouraged to consult several sources of information before making important decisions regarding matters such as the choice of an institution, course of study or the status of qualifications. Individuals wishing to have their qualifications recognized for work or further study are advised to consult the competent authorities of the country in which they are seeking to have their qualifications recognised. It is also important to note that some institutions not on the national lists may offer quality programmes. Users are encouraged to contact the national contact point(s) for each country, if necessary, for further information.

Print E-mail this Page

Disclaimer Privacy policy UNESCO Education Contact ©UNESCO 1995-2007

Participating Countries

[Pilot Phase]

- Argentina
- Australia,
- Canada,
- China,
- Egypt,
- Jamaica,
- Japan,
- Kenya,
- Malaysia,
- Nigeria,
- Norway,
- Switzerland,
- United Kingdom,
- United States

- Launched 30 April 2008 -

What is the Portal on Higher Education Institutions?

- This Portal is a follow up to the UNESCO/OECD Guidelines for Quality Provision in Cross-border Higher Education.
- It targets students, employers, and other interested parties (e.g. credential evaluators).
- It aims to provide students, employers and other interested parties with access to authoritative and up-to-date information on the status of HEIs and QA in participating countries.

Country Information on the Portal

The screenshot shows the UNESCO Portal on Higher Education Institutions for China. The page is titled "UNESCO Portal on Higher Education Institutions" and is for the country of China. It features a navigation menu with categories like Education, Natural Sciences, Social & Human Sciences, Culture, and Communication & Information. The main content area is divided into sections: "List of Countries" (with a dropdown menu set to "China"), "Project", "Resources", and "Themes". The "Project" section includes links for "About us" and "Resources". The "Resources" section includes links for "Study Abroad" and "Guidelines Cross-border Higher Education". The "Themes" section includes links for "Higher Education and ICTs", "Quality Assurance and Recognition", and "Cross-Border Higher Education". The main content area for China includes a list of links for institutions, programmes, and information for students. It also provides information on the national focal point, Mr. Che Weimin, and the definition of a "Recognized Higher Education Institution" in China. The page is in English and Chinese.

UNESCO.org Education Natural Sciences Social & Human Sciences Culture Communication & Information

United Nations Educational, Scientific and Cultural Organization

EDUCATION

Text Sitemap OK Advanced search English Français Español

UNESCO.org / Education / Higher Education / UNESCO Portal on Higher Education Institutions /

List of Countries UNESCO Portal on Higher Education Institutions

Choose

China

- [Institutions recognized by competent authorities](#)
- [Programmes recognized by competent authorities](#)
- [Information for students planning to study in the country](#)
- [Information on the higher education system](#)
- [Foreign credential assessment and recognition](#)
- [Financial assistance opportunities](#)
- [Cross-border higher education](#)
- [National information centre](#)

This Information has been provided by:

- Ministry of Education of the People's Republic of China.
[English](#) | [Chinese](#)

National Focal Point:

Mr Che Weimin
Director of Division, Chinese Service Center for Scholarly Exchange (CSCSE)
Email: wmche@cscse.edu.cn

Definition of "Recognized Higher Education Institution" in China: Not available

1. Higher education institutions recognized by competent authorities:

- [List of recognized higher education institutions in China](#)
[English](#) | [Chinese](#)
- [List of Chinese Institutions admitting foreign students](#)
[English](#) | [Chinese](#)

[Back to top](#)

2. Higher education programmes recognized by competent authorities:

- [List of Undergraduate Programmes.](#) [Chinese](#)
- [List of Postgraduate Programmes.](#) [Chinese](#)
- [List of China-Foreign Jointly Run Programmes.](#) [Chinese](#)

[Back to top](#)

Project

- About us

Resources

- Study Abroad
- Guidelines Cross-border Higher Education

Themes

- Higher Education and ICTs
- Quality Assurance and Recognition
- Cross-Border Higher Education

1. Institutions recognized by competent authorities
2. Higher education programmes recognized by competent authorities
3. Information for students planning to study in the country
4. Information on the higher education system
5. Foreign credential assessment and recognition
6. Information on financial assistance opportunities
7. Cross-border higher education
8. National Information Centre
9. Other information sources
10. Definition of key terms

BEWARE



DEGREE MILLS & BOGUS COLLEGES

Bogus Institutions misusing UNESCO's name

- All levels of abuse and use. The claims may range from 100% false to not quite untrue
- A multitude of modes:
 - all modes are about establishing a false connection or emphasizing a real link with UNESCO to give the impression of being an internationally recognized provider of higher education
 - One institution may use 1-3 different modes
 - Institutions change rapidly

ACADEMIC FRAUD



Accreditation

St. Regis is Nationally Chartered (1984) and FULLY ACCREDITED by the Higher Education Commission of the Education Ministry of Liberia, which grants recognition to post-secondary education institutions in Liberia including University of Liberia and Cuttington University College.

The Republic of Liberia is one of the earliest United Nations Educational Organization [UNESCO Higher Education Partners](#), and a historical [American colony](#). St. Regis University is accredited as a degree-awarding post-secondary institution of higher education in the form of a university by the National Commission on Higher Education, the only [Higher Education accrediting authority](#) of the Ministry of Education in the Government of Liberia.

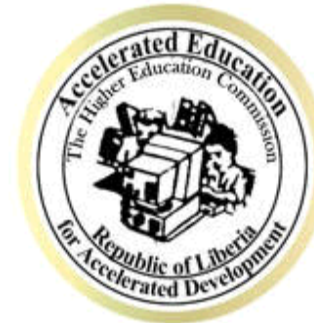

Federal accreditation by a National Government representative college or university, and the validity of awarded accreditation

'Degree evaluators in the United States and abroad accredited by a nation's Ministry of Education, it is viewed as a nationally recognized degree in other countries.'

St. Regis University is dedicated to meet and often exceed education credentialing in the Distance Education area

From 'The [Perspective](#)' (Atlanta, Georgia): "Liberian Government 2003".

For telephone or postal verification accreditation, you may contact:

The Embassy of Liberia
5201 16th Street, N.W.
Washington, DC 20011
(202) 723-0437

www.liberianembassy.com

For telephone or postal verification accreditation, you may contact:

**UNESCO Division of Higher Education
- Tel: (+33.1) 45681106**

➤ Support for UNESCO's framework

➤ Links to UNESCO



Recognizing Excellence

- Home
- Institutions
- Complaints
- Advertisements
- Contributions
- Application
- Contact Us
- UNESCO
- World Health Org.

About EAA

Information, Policies, Requirements, Procedures, and More

This Page is divided into several informative sections. **CLICK** on the section title below, or **SCROLL** down to the desired section. We hope you find this information helpful. Thank you for your interest.

- EAA Code of Ethics
- EAA Mission Statement
- Why Be EAA Accredited
- General Information
- Policies
- Accreditation Information
- Credentials
- Sponsor / Contributor Information
- Advertiser Information

Direct links to UNESCO & World Health Org

EAA and its accredited institutions accept and adopt "The Recommendations of the World Conference on Higher Education, sponsored by UNESCO", and the applicable sections of the "UNESCO Guidelines for Quality Provision in Cross-Border Higher Education"

and encourage
and staff.

stitution or person is discriminated against or de
n, Religion, Economic Status, Class or Social Sta

Require without preference or favoritism, all accredited insti
by the Ethics Code, Accreditation Requirements and

se of; Gender, Race,

knowledge, and abide
institutions.

Which way to go?



Giacometti sculpture – UNESCO Paris

EXPERT GROUP: Effective practices



- UNESCO and the Council on Higher Education Accreditation (CHEA) are developing suggestions for international effective practice on degree mills with an expert group
- UNESCO and COL alerting the developing countries to the threat of degree mills
- The UNESCO Portal one of the responses

Part 2

What can you do about degree mills?

- No magic bullet
- Action on various fronts

Council for
Higher Education
Accreditation

®
CHEEA

Degree Mills



WHAT



CRIME?



“A degree mill offers a credential purely in exchange for payment and nothing else”

Detecting Degree Mills

Filter Statements

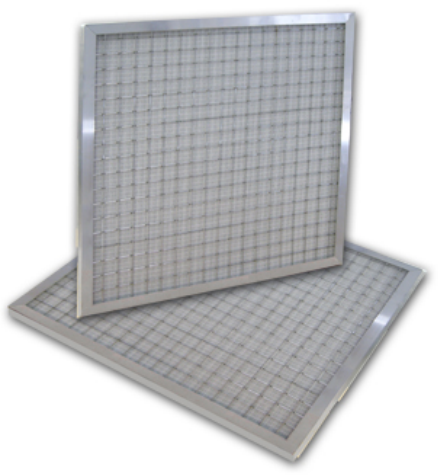

- Does not have legal authority to award degrees in its home jurisdiction.
- Requires little attendance, either in classrooms or online.
- Requires little, if any, coursework or assignments.
- Limits its contact information to a phone number or an e-mail address.
- Makes false claims about external quality assurance or accreditation.

Detecting Degree Mills

Filter Statements

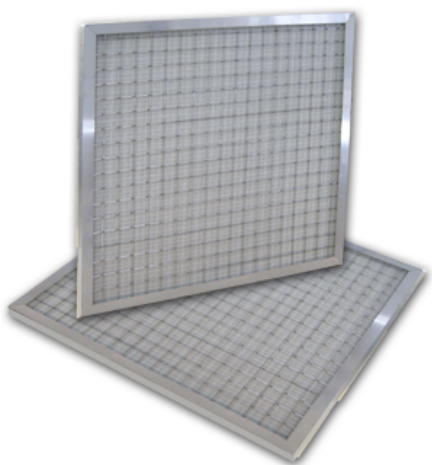

- Issues degrees that are not accepted for licensing or graduate admission in the home jurisdiction.
- Does not provide verifiable faculty lists, or lists faculty with credentials from degree mills.
- Features websites that copy or imitate material from legitimate organisations.
- Have websites with internet domain registration obscured by a privacy service.



Closing down degree mills in Nigeria!

STEP 1: BUYER BEWARE!

“Help students become savvy consumers and research their options”

Consult STUDY ABROAD

and

UNESCO's portal of white lists:

<http://tinyurl.com/RecognizedHE>

<http://tinyurl.com/RecognisedHE>

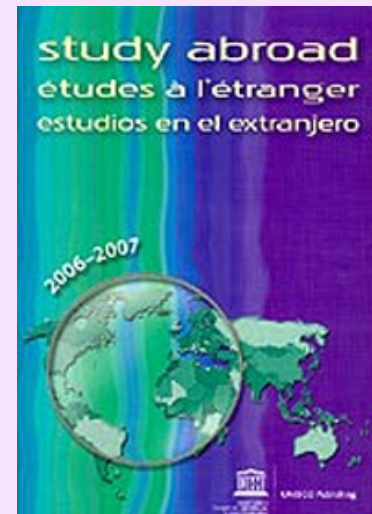

STEP 2: GOVERNMENTS

must want to protect the integrity of their higher education systems...



COAL + IRON ORE + HIGHER EDUCATION = \$\$

STEP 2: GOVERNMENTS

must want to protect the integrity of their higher education systems...

PROTECT TERMS LIKE:

- * University
- * Accreditation



STEP 2: GOVERNMENTS

must want to protect the integrity of their
higher education systems...

A special challenge for Small States:

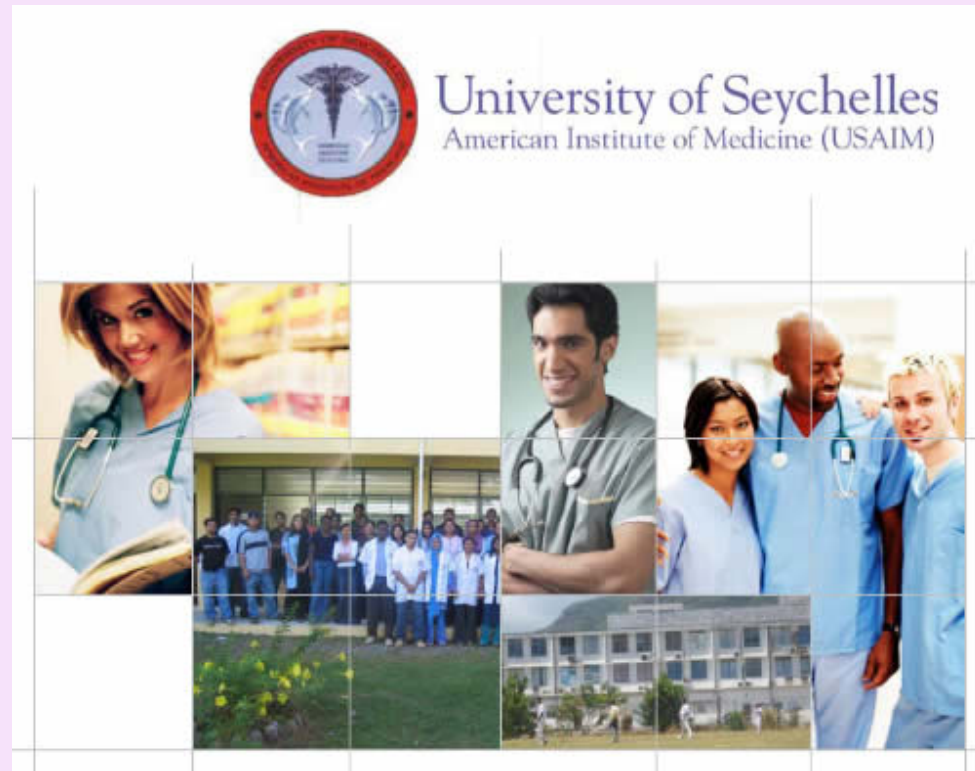

STEP 2: GOVERNMENTS

must want to protect the integrity of their higher education systems...

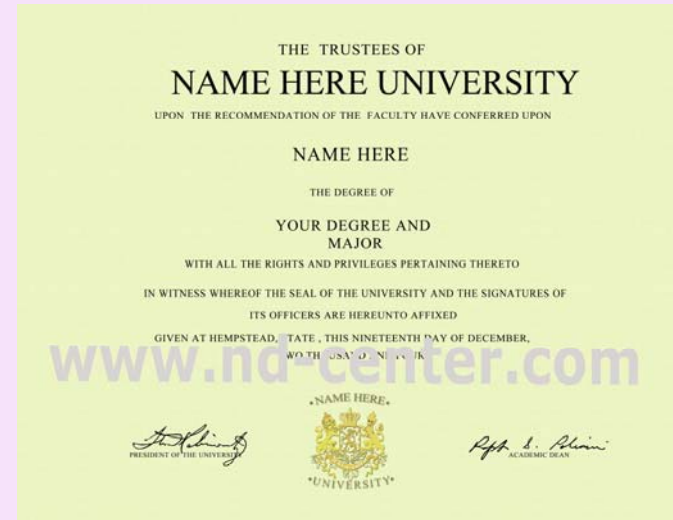

STEP 2: GOVERNMENTS

must want to protect the integrity of their higher education systems...



Nigeria: a robust approach

STEP 3: TRANSPARENT PROCESSES

Quality assurance systems

- List of accredited/recognised institutions and put on UNESCO portal;
- Raise quality of HEIs generally;
- Qualifications frameworks.



The Virtual University for Small States of the Commonwealth

A Transnational Qualifications Framework

(developed with the help of the South African Qualifications Authority)



The Commonwealth of Learning



STEP 4: AVOID FUNDING DEGREE MILLS OR THEIR STUDENTS



STEP 5:CHECK CREDENTIALS

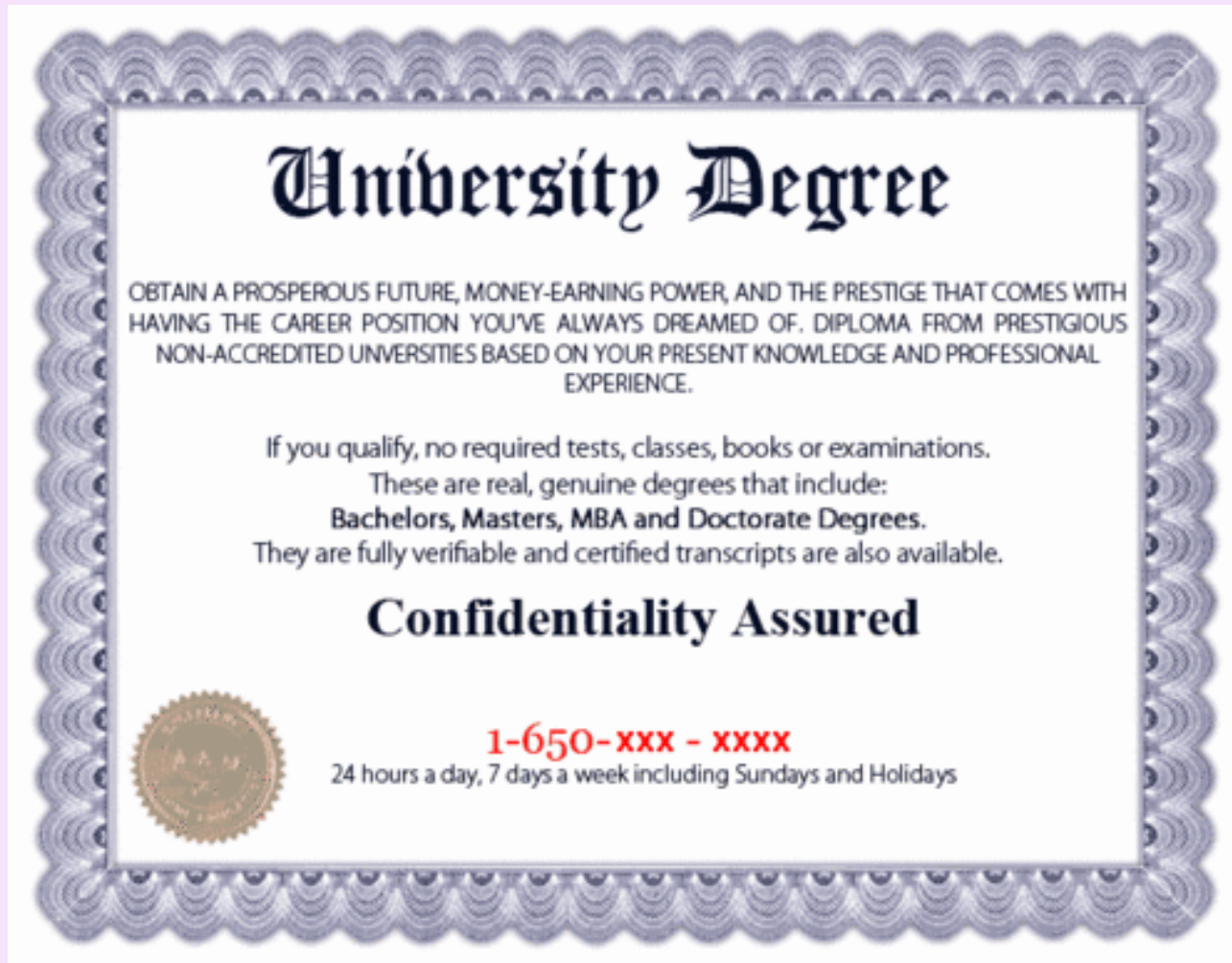

University Degree

OBTAIN A PROSPEROUS FUTURE, MONEY-EARNING POWER, AND THE PRESTIGE THAT COMES WITH HAVING THE CAREER POSITION YOU'VE ALWAYS DREAMED OF. DIPLOMA FROM PRESTIGIOUS NON-ACCREDITED UNIVERSITIES BASED ON YOUR PRESENT KNOWLEDGE AND PROFESSIONAL EXPERIENCE.

If you qualify, no required tests, classes, books or examinations.
These are real, genuine degrees that include:
Bachelors, Masters, MBA and Doctorate Degrees.
They are fully verifiable and certified transcripts are also available.

Confidentiality Assured

1-650-xxx - xxxx
24 hours a day, 7 days a week including Sundays and Holidays

200,000 phony credentials sold annually in the USA

STEP 5:CHECK CREDENTIALS



200,000 phony credentials sold annually in the USA

STEP 5: CHECK CREDENTIALS

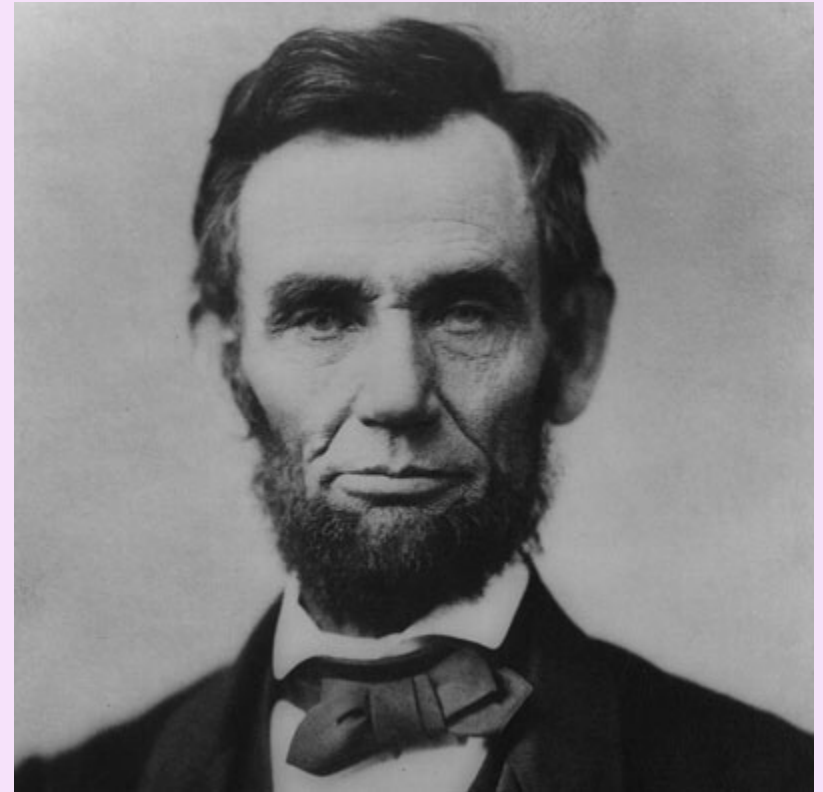
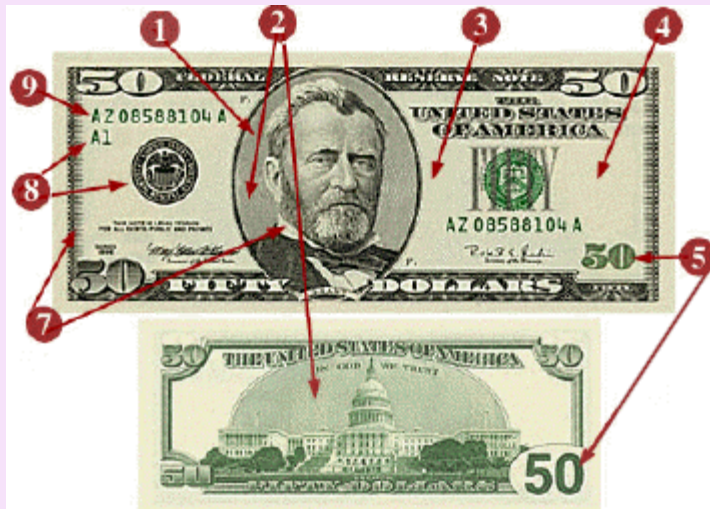

30-50% of US currency counterfeit in 1860

STEP 5: CHECK CREDENTIALS

PUBLIC KEY CRYPTOGRAPHY

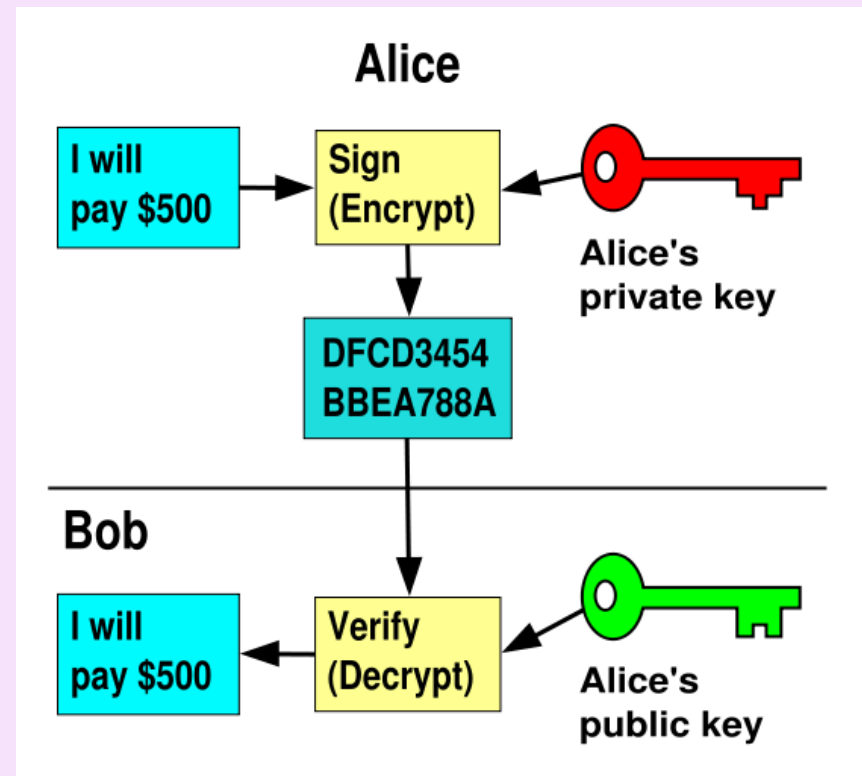
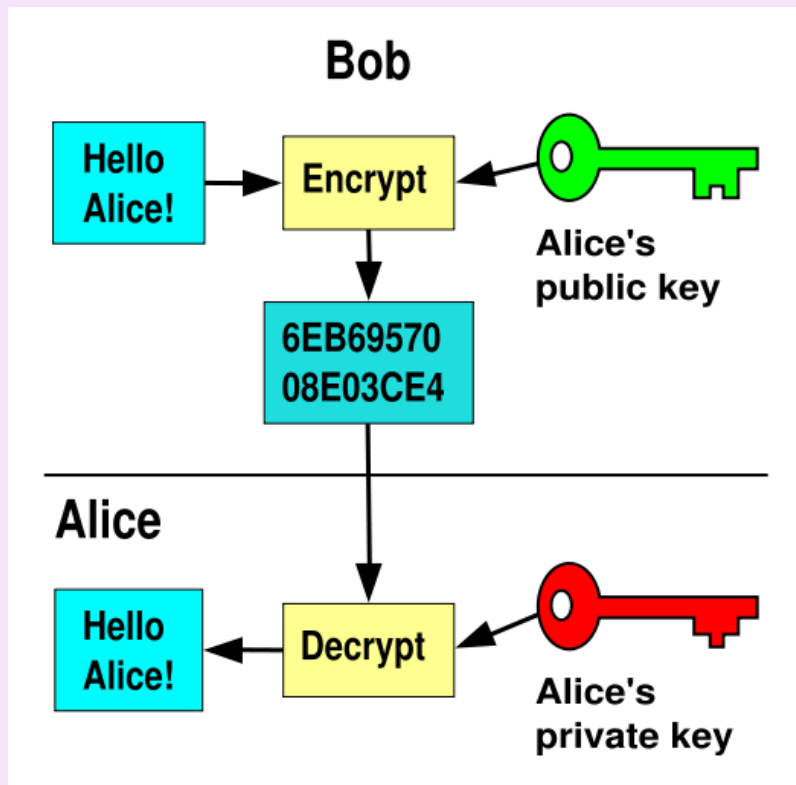

STEP 6: INTERGOVERNMENTAL BODIES



Member of UNESCO



Clayton University

[Home](#)

[Forms](#)

[Contact Clayton](#)

1. Who accredits Clayton University?

Clayton University is an international University, having affiliates in European, Asian, and African countries.

Although Clayton University is not accredited by an accrediting agency recognized by the United States Secretary of Education, it is a member of UNESCO.

Our programs are approved by recognized professional institutes that offer rigorous courses in various academic areas. Currently, the Institute of Cost and Executive Accountants, Society of Business Practitioners have approved us.

STEP 6: INTERGOVERNMENTAL BODIES



The Doctor of Medicine (M.D.) program at the Medical University of the Americas is recognized by the World Health Organization and listed in the latest World Directory of Medical Schools.



Our Campus

STEP 7: INFORMAL SYSTEM OF ALERTS AND BLACK LISTS

Informal because:

- Vexatious litigation
- Degree mills like chameleons



STEP 7: INFORMAL SYSTEM OF ALERTS AND BLACK LISTS



BEWARE



DEGREE MILLS & BOGUS COLLEGES

Council for
Higher Education
Accreditation

®
CHEEA

Degree Mills





s.uvalic-trumbic@unesco.org

Thank you

jdaniel@col.org

